

OFFICE FURNITURE  
**CHALLENGE** series

Challenge Series

OFFICE



The Challenge series features combination of color and soft finish and ergonomic design that prioritize user convenience and a variety of units for a seamless layout. Reduce unnecessary area of the desk to implement an efficient use of space and a comfortable working space for the current office.





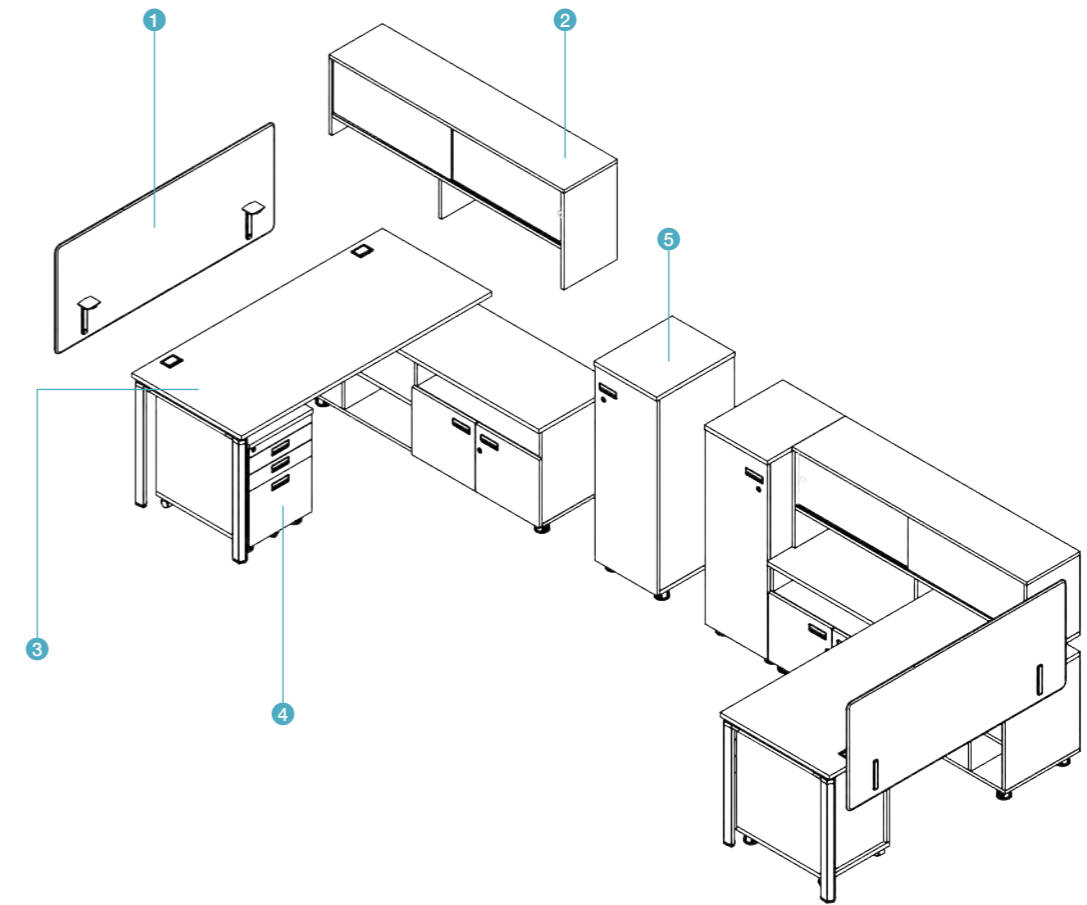

# CHALLENGE series

The Challenge series is a basic design that allows you to create a workstation that's right for you, in a flexible combination with a variety of storage.



## Basic structures

Image	Item	Model No.	Description
	Screen	DS0166R	The screen distinguishes the personal space with natural communication at the proper height and helps to organize the objects of the individual neatly. You can also attach a simple note using a magnet to the front memo board with the accessory on top.
	Top Storage	BS015H	Optional top storage replaces the panel to provide eye-catching, personal space and expand your storage space.
	Desk	CHD0165SD	Side cabinets combined with desks provide personal accessibility and convenient storage.
	Mobile Pedestal	DP131	Security management of personal objects is possible, and sufficient storage space is provided for efficient storage of various materials and supplies.
	Locker	LK045	Tower units, maximize personal storage, allow you to store and manage a variety of items.



## Design for office



### DETAIL

#### 01\_ Simple design

The modern base is simple, and the luxurious desk is not constrained by space, making it easy to relocate and move around according to the layout.

#### 02\_ Wiring Cap

Wiring cap considering safety and convenience provides enough space for vertical wiring with ABS injection cover.

#### 03\_ Inserted Handle

The metallic material and simple Inserted handle are safe to use and the unique design fits well into modern offices.

#### 04\_ Leveling Feet

The plastic injection leveler is attached to the bottom, making it easy to adjust the level even without uneven floor.







**DESK**

Desk

- CHD008 W800×D700×H720
- CHD010 W1000×D700×H720
- CHD012 W1200×D700×H720
- CHD014 W1400×D700×H720
- CHD016 W1600×D700×H720
- CHD018 W1800×D700×H720



Desk

- CHD014UP W1400×D700×H720
- CHD016UP W1600×D700×H720
- CHD018UP W1800×D700×H720



Desk

- CHD0164SD W1600×D1500×H720
- CHD0184SD W1800×D1500×H720

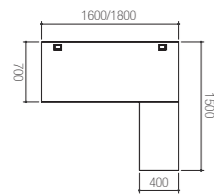

Desk

- CHD0165SD W1600×D1500×H720
- CHD0185SD W1800×D1500×H720

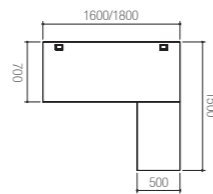

Desk

- CHD014UPS W1400×D700×H720
- CHD016UPS W1600×D700×H720



Desk

- CHD0165SDD W1600×D1500×H720
- CHD0185SDD W1800×D1500×H720



**BASIC COLOR**



**DRAWER**

Mobile Pedestal

- DP130 W403×D580×H605

※ Injection internal drawer



Mobile Pedestal

- DP230DW W403×D550×H603

※ Wood internal drawers



Mobile Pedestal

- DP131 W403×D580×H605

※ Internal injection drawer (bottom file)



**SIDE CABINET**

Side Cabinet

- SD075 W700×D500×H720
- SD085 W800×D500×H720

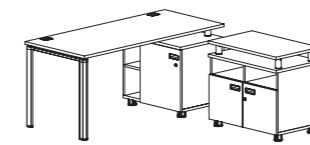

SD085 + CHD016UP

Side Cabinet

- BS082SD W800×D400×H607

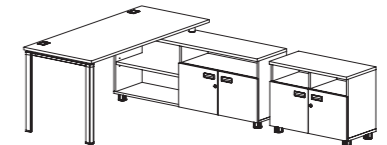

BS082SD + CHD0164SD

Side Cabinet

- SDCW853 W800×D500×H720



In door lock

**BASIC COLOR**

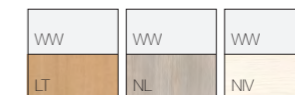



**SCREEN**

Screen

- DS0086R** W800×D15×D800
- DS0106R** W1000×D15×D800
- DS0126R** W1200×D15×H800
- DS0146R** W1400×D15×H800
- DS0166R** W1600×D15×H800
- DS0186R** W1800×D15×H800

※ Rounded Wooden Screen



Screen(30T)

- NWSC0012** W1200×D30×H800
- NWSC0014** W1400×D30×H800
- NWSC0016** W1600×D30×H800
- NWSC0018** W1800×D30×H800



Screen(15T)

- NWUS012** W1200×D15×H800
- NWUS014** W1400×D15×H800
- NWUS016** W1600×D15×H800
- NWUS018** W1800×D15×H800



**TOP STORAGE**

Top Storage

**BS015H** W1500×D360×H553

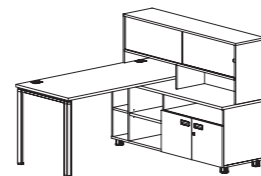

**BS015H** + CHD0165SD

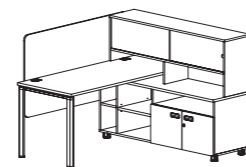

**BS015H** + CHD0165SD + DS0146R

Top Storage

**BS007NMH** W700×D300×H440

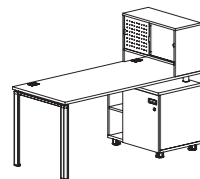

**BS007NMH** + CHD016UP



Top Storage

**BS007H** W700×D300×H440

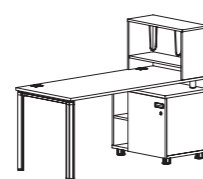

**BS007H** + CHD016UP



**MEMO BOARD**

Memo Board

**DS030A** W300×D19×H350



※ Hanging Over Wood Screen  
(Magnetic Use)

Memo Board

**DS0618A** W600×D19×H100



※ Hanging Over Wood Screen  
(Magnetic Use)

**BASIC COLOR**



**BASIC COLOR**

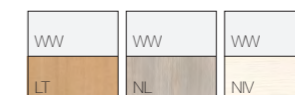

**SCREEN FABRIC**





※ When placing a single wardrobe next to a desk, make sure that it is fixed with a fixed hardware.(Risk of Falling)



Locker for 1 (Regular type)



Locker for 1 with Shelves



Locker for 1 with Drawer

**LOCKER**

Locker  
**LK1237** W200×D700×H1160



Locker  
**LK045** W400×D500×H1160



Locker  
**LK1237B** W200×D700×H1160



Locker  
**LK1437B** W400×D700×H1160



Locker  
**LK2437** W400×D700×H1160



Locker  
**LK1437P** W400×D700×H1160



Locker  
**LK2437B** W400×D700×H1160



In door lock

**BASIC COLOR**

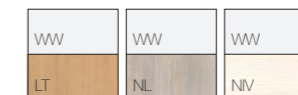



# CHALLENGE series

With an open structure and design that supports smooth communication, flexible space partitioning, and various items that can be freely applied as needed differentiated solutions complete the special competitiveness of the Smart Office era.



No.	Model No.	Dimension	Qty	
1	Desk	<b>CHD0165SDD</b>	W1600×D1500×H720	4
2	Locker	<b>LK045</b>	W400×D500×H1160	4
3	Top Storage	<b>BS015H</b>	W1500×D360×H553	4
4	Screen	<b>NWSC0014</b>	W1400×D30×H800	4
Total			16	



No.	Model No.	Dimension	Qty	
1	Desk	<b>CHD016UP</b>	W1600×D700×H720	3
2	Side Cabinet	<b>SDCW853</b>	W800×D500×H720	3
3	Screen	<b>NWSC0014</b>	W1400×D30×H800	3
Total			9	



No.	Model No.	Dimension	Qty	
1	Desk	<b>CHD014</b>	W1400×D700×H720	2
2	Mobile Pedestal	<b>DP130</b>	W403×D580×H605	2
3	Locker	<b>LK2437</b>	W400×D700×H1160	1
4	Screen	<b>NWSC0014</b>	W1400×D30×H800	2
Total			7	



No.	Model No.	Dimension	Qty	
1	Desk	<b>CHD0165SDD</b>	W1600×D1500×H720	2
2	Locker	<b>LK045</b>	W400×D500×H1160	2
3	Top Storage	<b>BS015H</b>	W1500×D360×H553	2
4	Screen	<b>NWSC0014</b>	W1400×D30×H800	2
Total			8	







Desk+Side Cabinet  
 +Locker+Screen+Task  
 Chair



Desk+Side Cabinet+Top  
 Storage+Locker+Screen+Task  
 Chair



Desk+Side Cabinet  
 +Bookshelf+Locker+Screen  
 +Task Chair



Desk+Side Cabinet+Top  
 Storage+Locker+Screen+Task  
 Chair



No.	Model No.	Dimension	Qty	
1	Desk	<b>CHD016UPS</b>	W1600×D700×H720	2
2	Locker	<b>LK2437B</b>	W400×D700×H1160	1
3	Screen	<b>NWSC0014</b>	W1400×D30×H800	2
Total			5	



No.	Model No.	Dimension	Qty	
1	Desk	<b>CHD016UPS</b>	W1600×D700×H720	4
2	Desk	<b>CHD0165SDD</b>	W1600×D1500×H720	1
3	Locker	<b>LK2437B</b>	W400×D700×H1160	2
4	Locker	<b>LK045</b>	W400×D500×H1160	1
5	Top Storage	<b>BS015H</b>	W1500×D360×H553	1
6	Screen	<b>NWSC0014</b>	W1400×D30×H800	3
Total			12	



No.	Model No.	Dimension	Qty	
1	Desk	<b>CHD0165SDD</b>	W1600×D1500×H720	2
2	Locker	<b>LK045</b>	W400×D500×H1160	2
3	Top Storage	<b>BS015H</b>	W1500×D360×H553	2
4	Screen	<b>NWSC0014</b>	W1400×D30×H800	1
Total			7	



No.	Model No.	Dimension	Qty	
1	Desk	<b>CHD0165SDD</b>	W1600×D1500×H720	2
2	Locker	<b>LK045</b>	W400×D500×H1160	2
3	Top Storage	<b>BS015H</b>	W1500×D360×H553	2
4	Screen	<b>NWSC0014</b>	W1400×D30×H800	2
Total			8	

